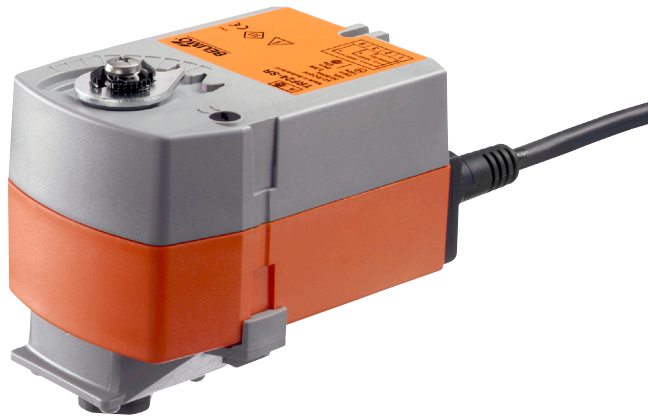

3-point rotary actuator with emergency control function for ball valves

- Nominal torque 2.5 Nm
- Nominal voltage AC 24 V
- Control 3-point
- Deenergised closed (NC)

Technical data

Electrical data	Nominal voltage	AC 24 V
	Nominal voltage frequency	50/60 Hz
	Nominal voltage range	AC 19.2...28.8 V
	Power consumption in operation	2.5 W
	Power consumption in rest position	1 W
	Power consumption for wire sizing	4 VA
	Connection supply / control	Cable 1 m, 4 x 0.75 mm ²
	Parallel operation	Yes (note the performance data)
Functional data	Torque motor	Min. 2.5 Nm
	Torque spring return	Min. 2.5 Nm
	Direction of rotation motor	Y=0 (A - AB = 0%)
	Direction of rotation spring-return	Deenergised NC, valve closed (A - AB = 0%)
	Manual override	No
	Angle of rotation	95°
	Running time motor	90 s / 90°
	Running time emergency control position	<25 s / 90°
	Sound power level motor	35 dB(A)
	Position indication	Mechanical
	Service life	Min. 60,000 emergency positions
	Safety	Protection class IEC/EN
Degree of protection IEC/EN		IP42
EMC		CE according to 2004/108/EC
Certification IEC/EN		IEC/EN 60730-1 and IEC/EN 60730-2-14
Mode of operation		Type 1
Rated impulse voltage supply / control		0.8 kV
Control pollution degree		3
Ambient temperature		-30...50°C
Non-operating temperature		-40...80°C
Ambient humidity		95% r.h., non-condensing
Maintenance	Maintenance-free	
Weight	Weight approx.	0.56 kg

Safety notes

- This device has been designed for use in stationary heating, ventilation and air conditioning systems and is not allowed to be used outside the specified field of application, especially in aircraft or in any other airborne means of transport.
- Only authorised specialists may carry out installation. All applicable legal or institutional installation regulations must be complied during installation.
- The device may only be opened at the manufacturer's site. It does not contain any parts that can be replaced or repaired by the user.
- Cables must not be removed from the device.
- The device contains electrical and electronic components and is not allowed to be disposed of as household refuse. All locally valid regulations and requirements must be observed.

Product features

- Principle of operation** The actuator moves the valve to the operating position at the same time as tensing the return spring. The valve is turned back to the emergency position by spring force when the supply voltage is interrupted.
- Simple direct mounting** Simple direct mounting on the ball valve with only one screw. The mounting orientation in relation to the ball valve can be selected in 90° steps.
- High functional reliability** The actuator is overload protected, requires no limit switches and automatically stops when the end stop is reached.

Electrical installation











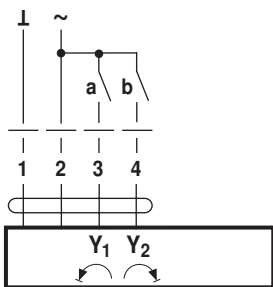



Notes

- Connection via safety isolating transformer.
- Parallel connection of other actuators possible. Observe the performance data.

Wiring diagrams

AC 24 V, 3-point



		NC		
a (Y1)	b (Y2)			
				A - AB = 100%
		stop		
				Y = 0
				A - AB = 0%

Cable colours:

- 1 = black
- 2 = red
- 3 = white
- 4 = white

Dimensions [mm]

Dimensional drawings

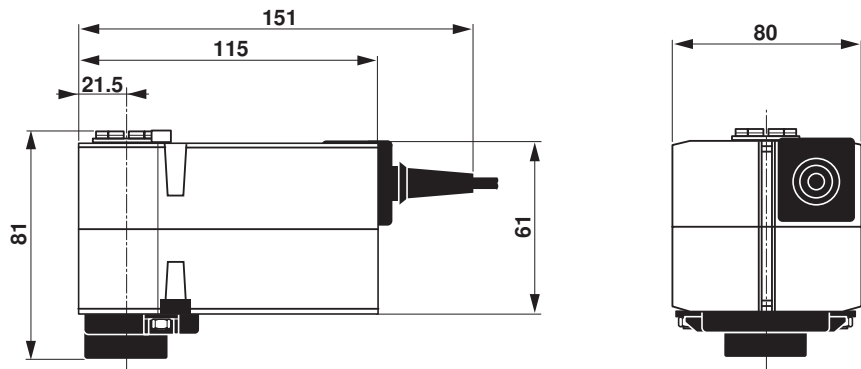

Further documentation

- Overview Valve-actuator combinations
- Data sheets for ball valves
- Installation instructions for actuators and/or ball valves
- General notes for project planning